

Dual Common-Cathode High-Voltage Schottky Rectifier

Low Leakage Current 5.0 μ A

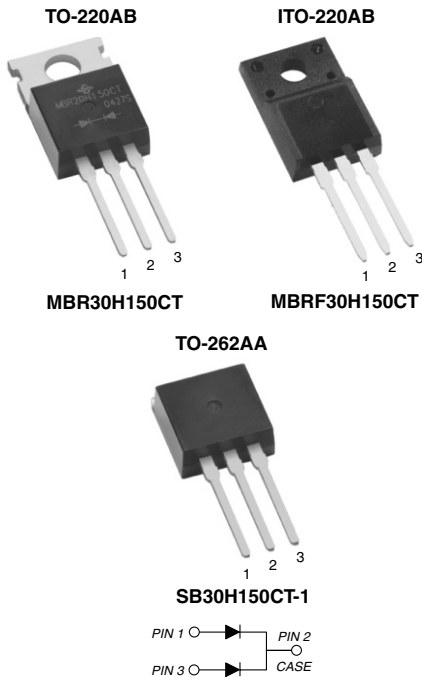

FEATURES

- Guardring for overvoltage protection
- Low power loss, high efficiency
- Low forward voltage drop
- High frequency operation
- Solder dip 260 °C, 40 s
- Component in accordance to RoHS 2002/95/EC and WEEE 2002/96/EC



RoHS
COMPLIANT

TYPICAL APPLICATIONS

For use in high frequency inverters, freewheeling and polarity protection applications.

MECHANICAL DATA

Case: TO-220AB, ITO-220AB, TO-262AA

Epoxy meets UL 94V-0 flammability rating

Terminals: Matte tin plated leads, solderable per J-STD-002 and JESD22-B102

E3 suffix for consumer grade, meets JESD 201 class 1A whisker test

Mounting Torque: 10 in-lbs maximum

Polarity: As marked

PRIMARY CHARACTERISTICS

$I_{F(AV)}$	2 x 15 A
V_{RRM}	150 V
I_{FSM}	260 A
V_F	0.75 V
T_J	175 °C

MAXIMUM RATINGS ($T_C = 25$ °C unless otherwise noted)

PARAMETER	SYMBOL	MBR30H150CT	UNIT
Maximum repetitive peak reverse voltage	V_{RRM}	150	V
Working peak reverse voltage	V_{RWM}	150	V
Maximum DC blocking voltage	V_{DC}	150	V
Maximum average forward rectified current	$I_{F(AV)}$	30 15	A
Peak forward surge current 8.3 ms single half sine-wave superimposed on rated load per diode	I_{FSM}	260	A
Peak repetitive reverse current per diode at $t_p = 2$ μ s, 1 kHz	I_{RRM}	1.0	A
Peak non-repetitive reverse surge energy per diode (8/20 μ s waveform)	E_{RSM}	10	mJ
Non-repetitive avalanche energy per diode at 25 °C, $I_{AS} = 2.0$ A, L = 10 mH	E_{AS}	20	mJ
Voltage rate of change (rated V_R)	dV/dt	10 000	V/ μ s
Operating junction and storage temperature range	T_J, T_{STG}	- 65 to + 175	°C
Isolation voltage (ITO-220AB only) from terminals to heatsink t = 1 min	V_{AC}	1500	V

ELECTRICAL CHARACTERISTICS ($T_C = 25\text{ }^\circ\text{C}$ unless otherwise noted)					
PARAMETER	TEST CONDITIONS		SYMBOL	VALUE	UNIT
Maximum instantaneous forward voltage per diode ⁽¹⁾	$I_F = 15\text{ A}$	$T_C = 25\text{ }^\circ\text{C}$	V_F	0.90	V
	$I_F = 15\text{ A}$	$T_C = 125\text{ }^\circ\text{C}$		0.75	
	$I_F = 30\text{ A}$	$T_C = 25\text{ }^\circ\text{C}$		0.99	
	$I_F = 30\text{ A}$	$T_C = 125\text{ }^\circ\text{C}$		0.86	
Maximum reverse current per diode at working peak reverse voltage ⁽¹⁾			I_R	5.0	μA
				1.0	mA

Note:

(1) Pulse test: 300 μs pulse width, 1 % duty cycle

THERMAL CHARACTERISTICS ($T_C = 25\text{ }^\circ\text{C}$ unless otherwise noted)					
PARAMETER	SYMBOL	MBR	MBRF	MBRB	UNIT
Typical thermal resistance per diode	$R_{\theta JC}$	1.7	4.0	1.7	$^\circ\text{C/W}$

ORDERING INFORMATION (Example)					
PACKAGE	PREFERRED P/N	UNIT WEIGHT (g)	PACKAGE CODE	BASE QUANTITY	DELIVERY MODE
TO-220AB	MBR30H150CT-E3/45	2.06	45	50/tube	Tube
ITO-220AB	MBRF30H150CT-E3/45	2.20	45	50/tube	Tube
TO-262AA	SB30H150CT-1E3/45	1.58	45	50/tube	Tube

RATINGS AND CHARACTERISTICS CURVES

($T_A = 25\text{ }^\circ\text{C}$ unless otherwise noted)

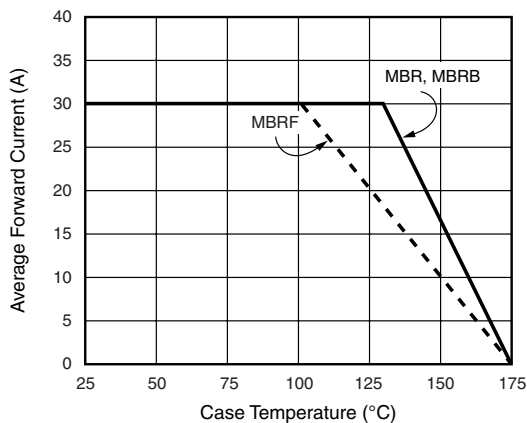

Figure 1. Forward Derating Curve (Total)

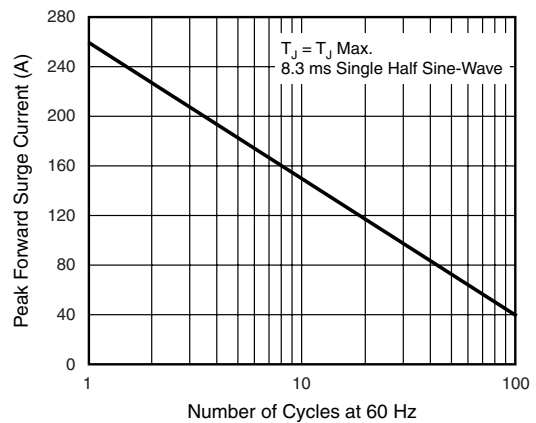

Figure 2. Maximum Non-Repetitive Peak Forward Surge Current Per Diode

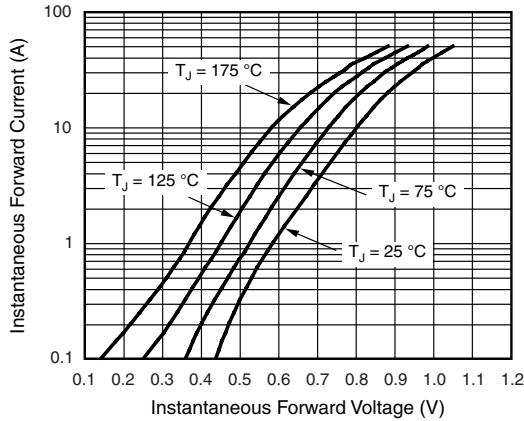

Figure 3. Typical Instantaneous Forward Characteristics Per Diode

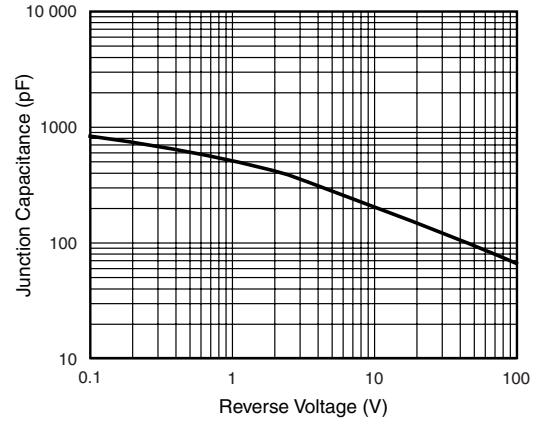

Figure 5. Typical Junction Capacitance Per Diode

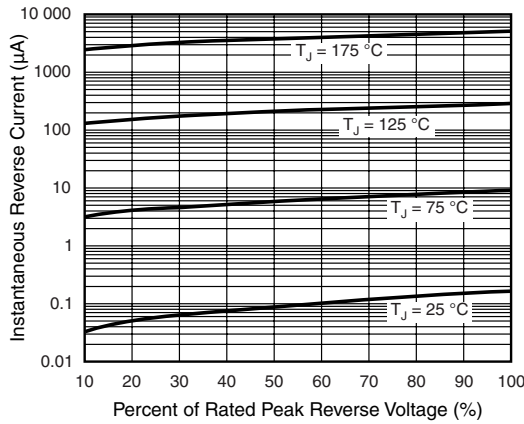

Figure 4. Typical Reverse Characteristics Per Diode

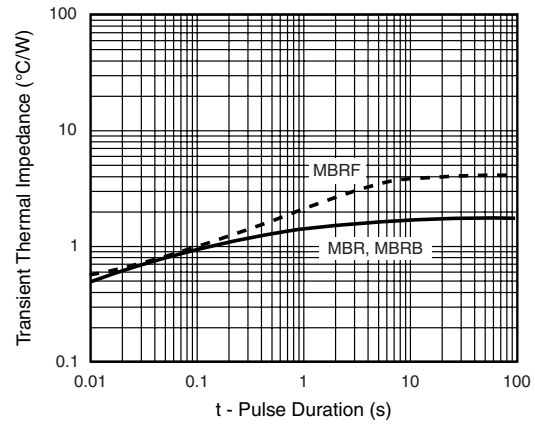
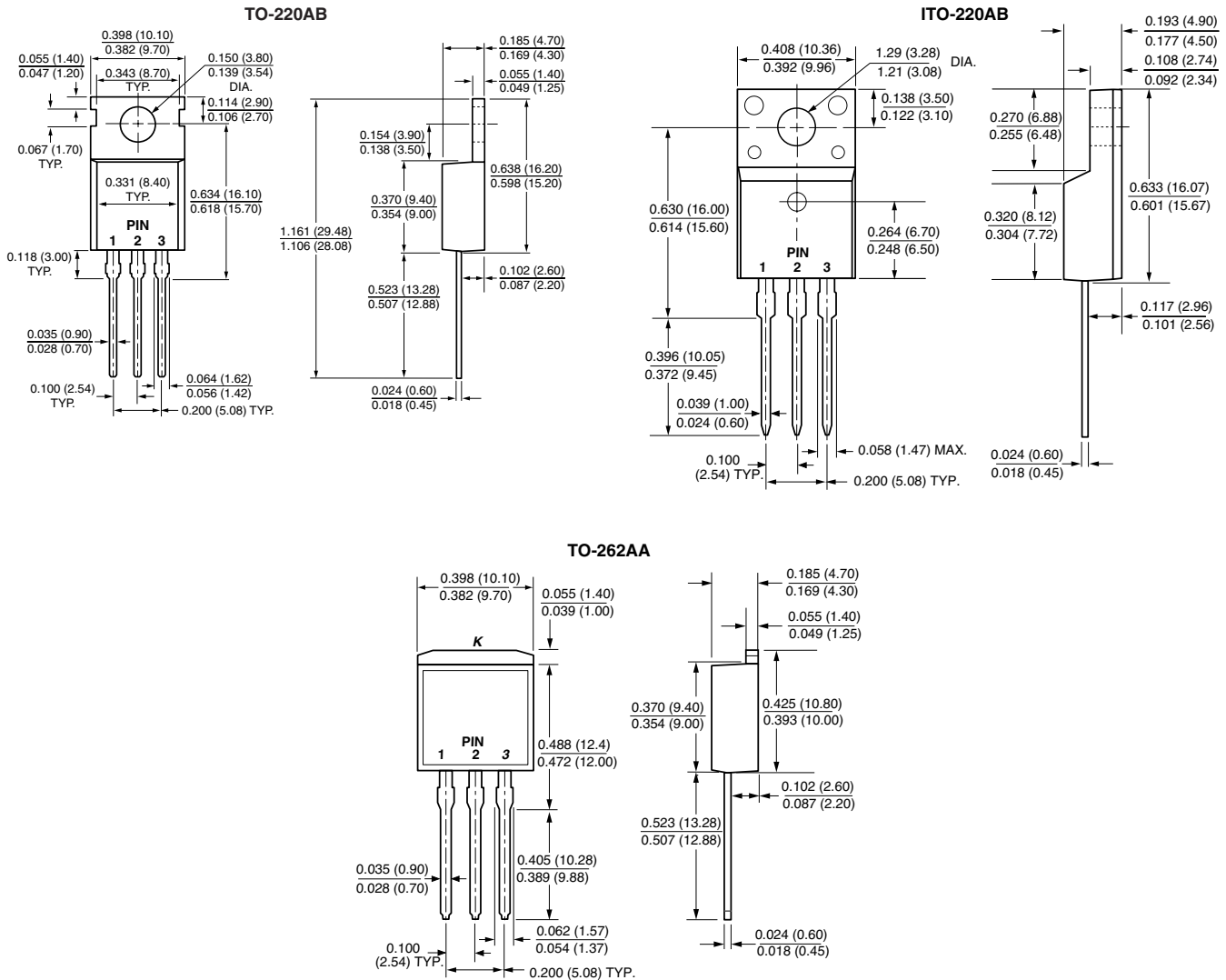

Figure 6. Typical Transient Thermal Impedance Per Diode

PACKAGE OUTLINE DIMENSIONS in inches (millimeters)





Disclaimer

All product specifications and data are subject to change without notice.

Vishay Intertechnology, Inc., its affiliates, agents, and employees, and all persons acting on its or their behalf (collectively, "Vishay"), disclaim any and all liability for any errors, inaccuracies or incompleteness contained herein or in any other disclosure relating to any product.

Vishay disclaims any and all liability arising out of the use or application of any product described herein or of any information provided herein to the maximum extent permitted by law. The product specifications do not expand or otherwise modify Vishay's terms and conditions of purchase, including but not limited to the warranty expressed therein, which apply to these products.

No license, express or implied, by estoppel or otherwise, to any intellectual property rights is granted by this document or by any conduct of Vishay.

The products shown herein are not designed for use in medical, life-saving, or life-sustaining applications unless otherwise expressly indicated. Customers using or selling Vishay products not expressly indicated for use in such applications do so entirely at their own risk and agree to fully indemnify Vishay for any damages arising or resulting from such use or sale. Please contact authorized Vishay personnel to obtain written terms and conditions regarding products designed for such applications.

Product names and markings noted herein may be trademarks of their respective owners.